

HARDWARE USER MANUAL



- **CBG5-0602-SFP**
- **CBG5-0602-SFP-T**

This document contains information, which is protected by copyright. Reproduction, adaptation or translation without prior permission is prohibited, except as allowed under the copyright laws.

Disclaimer

Leonton Technologies, Co. Ltd. provides this manual without warranty of any kind, expressed or implied, including but not limited to the implied warranties of merchantability and fitness for a particular purpose. Leonton Technologies, Co. Ltd. may make improvements and/or changes to the product and/or specifications of the product described in this manual, without prior notice. Leonton Technologies, Co. Ltd. will not be liable for any technical inaccuracies or typographical errors found in this guide. Changes are periodically made to the information contained herein and will be incorporated into later versions of the manual. The information contained is subject to change without prior notice.

FCC Notice

This equipment has been tested and found to comply with the limits for a Class-A digital device, pursuant to Part 15 of the FCC rules. These limits are designed to provide reasonable protection against harmful interference in a residential installation. This equipment generates, uses, and can radiate radio frequency energy. It may cause harmful interference to radio communications if the equipment is not installed and used in accordance with the instructions. However, there is no guarantee that interference will not occur in a particular installation. If this equipment does cause harmful interference to radio or television reception, which can be determined by turning the equipment off and on, the user is encouraged to try to correct the interference by one or more of the following measures:

- Reorient or relocate the receiving antenna.
- Increase the separation between the equipment and receiver.
- Connect the equipment into an outlet on a circuit different from that to which the receiver is connected.
- Consult the dealer or an experienced radio/TV technician for help.

Caution: Any changes or modifications not expressly approved by the grantee of this device could void the user's authority to operate the equipment.

Déclaration FCC

Cet équipement a été testé et reconnu conforme aux limites de la classe A pour les équipements numériques, conformément à la section 15 des Réglementations FCC. Ces limites sont conçues pour fournir une protection raisonnable contre toutes interférences nuisibles dans un milieu résidentiel. Cet équipement génère, utilise, et peut émettre de l'énergie de fréquence radio et, s'il n'est pas installé et utilisé conformément au manuel d'instruction, peut perturber la réception radio. Cependant, il n'est pas garanti que l'équipement ne produira aucune interférence dans une installation particulière. Si cet équipement cause des interférences nuisibles à la réception radio ou télévisée, qui peuvent être déterminées en l'éteignant et le rallumant, l'utilisateur est encouragé à essayer de remédier au problème en prenant les mesures suivantes:

- Réorienter ou déplacer l'antenne réceptrice.
- Augmenter la distance entre l'équipement et le récepteur.
- Connecter l'équipement à une prise secteur sur un circuit différent de celui utilisé par le récepteur.
- Consulter le négociant ou un technicien radio/TV expérimenté.

Attention: Tout changement ou modification non expressément approuvé par le concessionnaire de cet appareil pourrait annuler l'autorité de l'utilisateur à utiliser l'équipement.

CE Mark Warning

This is a Class-A product. In a domestic environment this product may cause radio interference in which case the user may be required to take adequate measures.

CE Mark Avertissement

Ceci est un produit de classe A. Dans un environnement domestique, ce produit peut être utilisé en présence d'interférences radio.

This document is the current official release manual. Please check our website (www.leonton.com) for any updated manual or contact us by e-mail (sales@leonton.com).

CONTENT

OVERVIEW	1
Key Features	1
Package Contents	2
Safety Precaution	2
HARDWARE DESCRIPTION	3
Physical Dimensions	3
Front Panel	4
Top View	4
LED Indicators	5
PoE Port LED Indicators	7
PoE Dip Switch	9
Relay Contact Alarm Warning	9
Ethernet Ports	10
Cabling	11
Wiring the Power Inputs	13
Wiring the Fault Alarm Contact	14
Grounding Note	14
MOUNTING INSTALLATION	15
DIN-Rail Mounting	15
Wall Mounting	17
HARDWARE INSTALLATION	19
Installation Steps	19
TROUBLE SHOOTING	21

OVERVIEW

This series is rated IP30 and installation by DIN Rail. Each unit of this industrial gigabit managed PoE compact size design for short installation space provided 4*10/100/1000Base-Tx with IEEE 802.3bt compliant ports (90W) convert to 2 dual-rate (100/1000) SFP slot, suitable for Ethernet and SFP conversion applications.

In order to prevent unregulated voltage, this series provides high EFT and ESD protection. This also allows it to function in harsh environments, as well as support power redundancy with a dual power input design with reverse polarity protection.

With one model having an operating temperature of -10°C ~ 65°C, and another with a wide operating temperature of -40°C ~ 75°C, this series is designed to meet any needs for industrial automation application and harsh environments.

Key Features

Interface & Performance

- Copper port support auto MDI/MDI-X function
- Embedded 4*10/100/1000Base-T(X) with bt PoE-PSE (90W/Port) and 2*100/1000 SFP Slot
- Store-and-forward switching architecture
- 8K MAC Address Table
- Supports 9.6Kbytes Jumbo Frame
- 4Mbits memory buffer

Power Input

- Dual 48-55VDC redundant power inputs
- 1 removable 6-contact terminal block
- Max. current 5.2A
- Max. PoE output: 240W
- For IEEE802.3bt applications, the power input not less than 53VDC is recommended

Certification

- CE/FCC
- UL 61010-1
- UL 61010-2-201

Operating Temperature

- Standard operating temperature model: -10°C ~ 65°C
- Extended operating temperature model (-T): -40°C ~ 75°C

Case/Installation

- IP30 protection (not certified by UL)
- DIN-Rail and wall mount design
- Installation in a pollution degree 2 industrial environment
- Standalone installation

Package Contents

- 1 - CBG5-0602-SFP(-T) - Unit weight: 0.948 kg (2.08 lb), Shipping weight: 1.224 kg (2.69 lb)
- 2 - Wall mounting brackets and screws
- 1 - Quick installation guide
- 1 - Mini-USB B type male to DB9 RS-232 female cable

Safety Precaution

Attention

If the DC voltage is supplied by an external circuit, please use a protection device on the power supply input. Supply by UL Listed industrial use power. The industrial Ethernet switch's hardware specs, ports, cabling information, and wiring installation will be described within this user manual.

Attention

Si la tension CC est fournie par un circuit externe, veuillez utiliser un dispositif de protection sur l'entrée d'alimentation. Fourniture par courant industriel homologué UL. Les spécifications matérielles, les ports, les informations de câblage et l'installation du câblage du convertisseur de média industriel seront décrits dans ce manuel d'utilisation.

Warning Labels

The caution label means that you should check the certain information on user manual when working with the device. (Shown in *Figure 1.1*)

Étiquettes d'avertissement

L'étiquette d'avertissement signifie que vous devez vérifier certaines informations sur le manuel d'utilisation lorsque vous travaillez avec l'appareil. (Montré dans la *Figure 1.2*)



Figure 1.1 - Caution Label
Figure 1.1 - Étiquette de mise en garde



Figure 1.2 - Hot Surface Warning Label
Figure 1.2 - Étiquette d'avertissement de surface chaude

HARDWARE DESCRIPTION

Physical Dimensions

Figure 2.1, below, shows the physical dimensions of CBG5-0602-SFP series.

(W x H x D) is 64.9mm x 110mm x 89.8mm

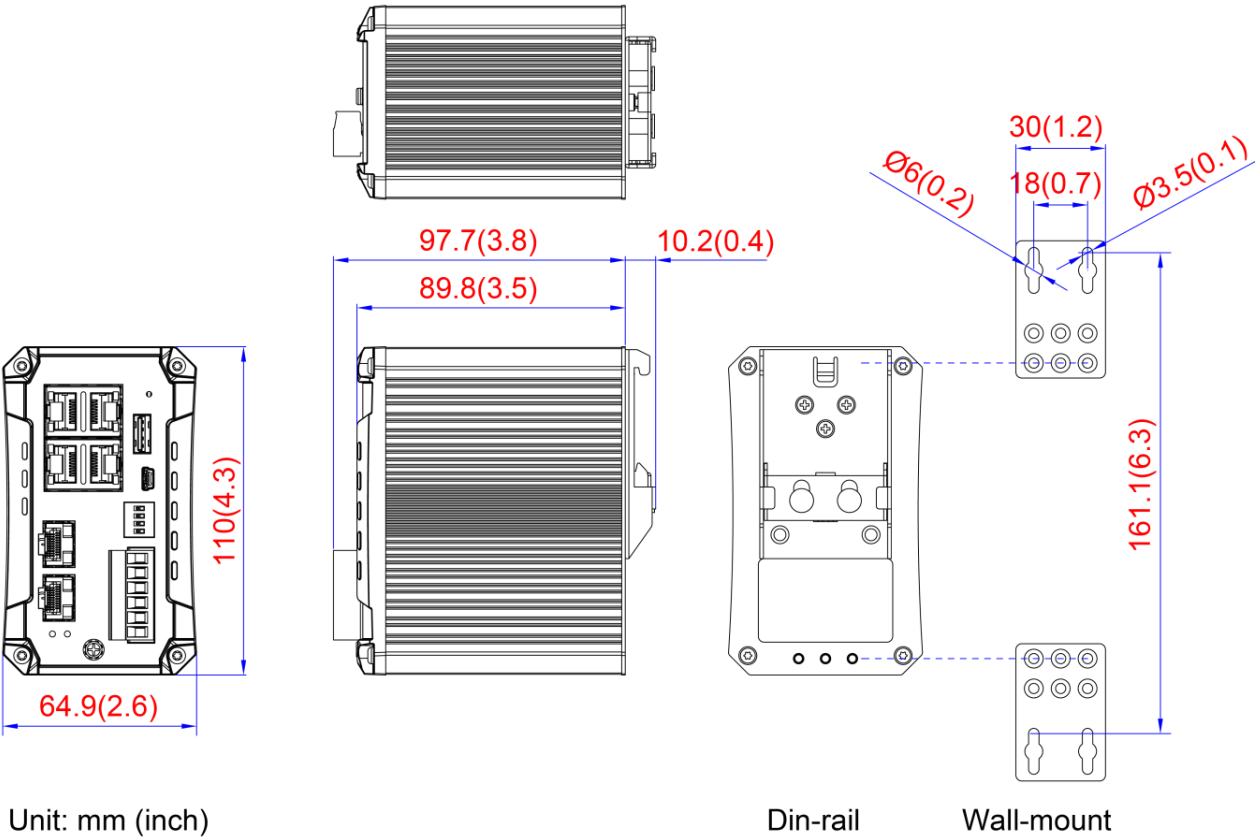

Figure 2.1: Physical Dimensions

Front Panel

The front panel of the CBG5-0602-SFP series industrial PoE+ gigabit Managed Ethernet Switch is shown below in Figure 2.2.

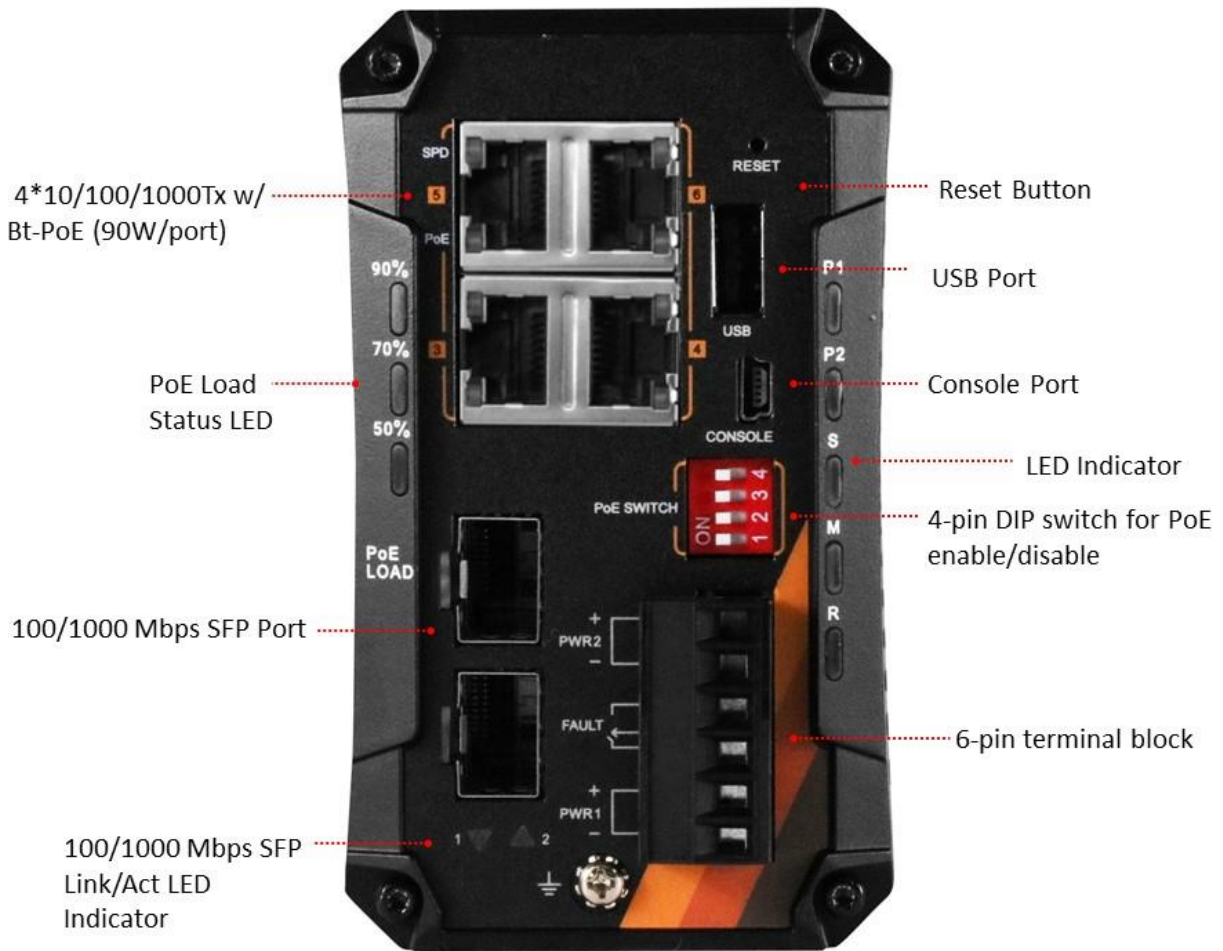

Figure 2.2: The Front Panel

Top View

Figure 2.3, below, shows the top panel of the CBG5-0602-SFP series switches that is equipped with one 4-pin removal terminal block connector for dual DC power inputs (48-55VDC).

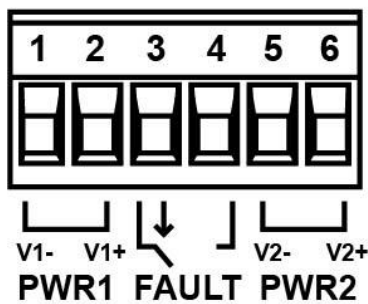



































Figure 2.3: Top Panel View

LED Indicators

There are LED light indicators located on the front panel of the industrial switch that display the power status and network status. Each LED indicator has a different color and has its own specific meaning, see below in Table 2.1.

Table 2.1: LED Indicators

LED	Color	Description	
P1	Green    	On	Power input 1 is active
		Off	Power input 1 is inactive
P2	Green    	On	Power input 2 is active
		Off	Power input 2 is inactive
STATUS	Red    	On	System booting
		On	The system ready and work fine, and there are no events occur
	Red    	Blinking	When the user presses the reset button
		On	The system is working normally, but the software set event occurs (ex. Power inactive / Ethernet port link-down.....).
MASTER	Green    	On	ERPS Owner Mode (Ring Master) is ready
		Off	ERPS Owner Mode is not active
RING	Green    	On	ERPS Ring Network is active and works well
		Blinking	ERPS Ring works abnormally or misconfigure
		Off	ERPS Ring Network is not active
PoE Load	 	Off	No PD connect

	Green 	On	The current of all connected PDs budget was ≤50%
	Green + Blue 	On	The current of all connected PDs budget was 51 - 70%
	Green+Blue+Red 	On	The current of all connected PDs budget was 71 - 90%
	Green+Blue+Red (red flash) 	On	The current of all connected PDs budget was 91 - 100%
SFP Link/Act/Speed (Port1-2)	Green	On	Connected to network, 1000Mbps
		Blinking	Networking is active, 1000Mbps
		Off	Not connected to network
	Amber	On	Connected to network, 100Mbps
		Blinking	Networking is active, 100Mbps
		Off	Not connected to network
Copper Port Link/ACT/Speed (Port3- 6)	Green 	On	Connected to network, 1000Mbps
		Flashing	Networking is active, 1000Mbps
		Off	Not connected to network
	Amber 	On	Connected to network, 10/100Mbps
		Flashing	Networking is active, 10/100Mbps
		Off	Not connected to network
PoE Mode (Port3-6)	Green 	On	IEEE 802.3bt connection (Single Signature PD Class 5~8/Dual Signature PD Channel Class 1~5)
		Off	No powered-device attached or power supplying fails
		Blinking (1 time/s)	Port link is recovered from failure event
	Amber 	On	IEEE 802.3af/at connection (Single Signature PD Class 0~4)
		Off	No powered-device attached or power supplying fails

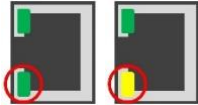
		Blinking (1 time/s)	Port link is recovered from failure event
	Green/Amber 	Alternating Amber(0.5s ec)& Green(0.5se c) blinking	The port is trying to recover from event failure (Frequency: 20secs/time)

PoE Port LED Indicators

The LED light indicators on the PoE copper port can help the user know if an event once occurs or is happening. When the event is happening, user can verify the event from the Dual-color LED status. If the port has recovered from an event, user can verify the event from the blinking frequency of the PoE LED(5 seconds as a cycle,).

- **PoE Budget Overload Event**

When the total PoE budget is overload (>100%), the PoE port of the lowest priority PoE port will be shutdown. The PoE LED of the port will act cyclically as below until the port is recovered from the event:

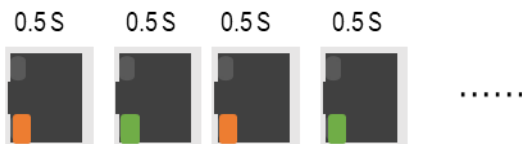

After the PoE port is recovered from the PoE budget overload event, the PoE LED of the will act cyclically as below until the event indicator is clear manually:

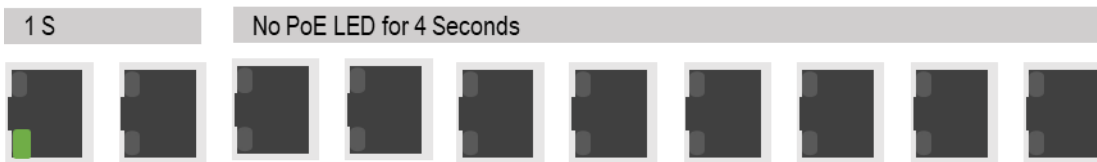

**AF/AT: Amber; BT: Green

- **PoE Port Over Current Event (Per Port)**

When the current limit of the specific PoE port is exceeded, the PoE power will be shutdown. The PoE LED of the port will act cyclically as below until the port is recovered from the event:



**AF/AT: Amber; BT: Green

After the PoE port is recovered from the PoE Port Over Current event, the PoE LED of the port will act cyclically as below until the event indicator is clear manually:



**AF/AT: Amber; BT: Green

- **Cable Short Event**

When the working PD encounters a cable short event, the PoE Port LED will act cyclically as below until the port is recovered from the event:

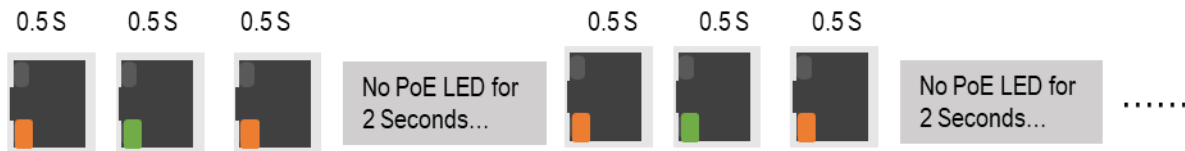

After the PoE port is recovered from the Cable Short event, the PoE LED of the port will act cyclically as below until the event indicator is clear manually:



**AF/AT: Amber; BT: Green

- **Dual PD Fail Event**

When one channel of the connected dual PD is failed, the PoE port will be shutdown. The PoE Port LED of the port will act cyclically as below until the port is recovered from the event:

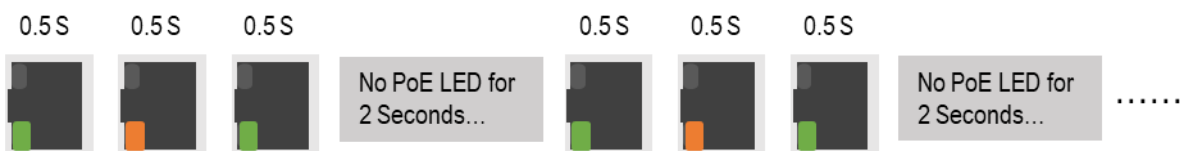

After the PoE port is recovered from the Dual PD Fail event, the PoE LED of the shutdown port will act cyclically as below until the event indicator is clear manually:

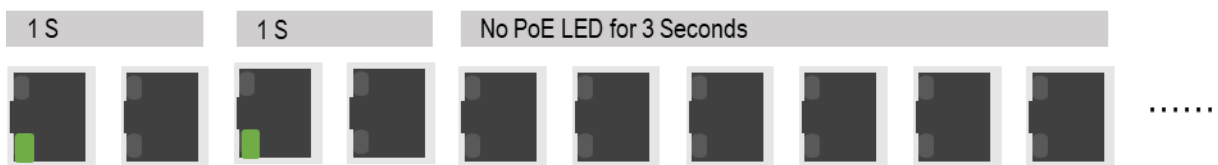

**AF/AT: Amber; BT: Green

[Notice]

1. The system will automatically retry to recover from the event failure every 20 seconds.
2. To clear the warning PoE Indicator of the recovered port, please re-plug the port cable or re-open the PoE function of the port via DIP Switch(>=2sec).

PoE Dip Switch

The 4-pin Dip Switch on the front panel of the Ethernet Switch works as the PoE Controller for PoE Port 1~Port 4.

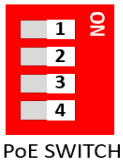

	<i>On</i>	<i>Off</i>
<i>PoE DIP Switch 1</i>	Enable Port 3 PoE Function	Disable Port 3 PoE Function
<i>PoE DIP Switch 2</i>	Enable Port 4 PoE Function	Disable Port 4 PoE Function
<i>PoE DIP Switch 3</i>	Enable Port 5 PoE Function	Disable Port 5 PoE Function
<i>PoE DIP Switch 4</i>	Enable Port 6 PoE Function	Disable Port 6 PoE Function

Relay Contact Alarm Warning

2-pin 1*24VDC@1A resistive normal open on 6-pin terminal block.

The relay contact alarm will be triggered when anyone of the pre-configured events occurs. User can configure the event warning for the events listed below. (Software Default: OFF)

The relay contact alarm will be triggered when anyone of the listed events occurs.

Key trigger event 1: Power-1 or Power-2 is inactive

Key trigger event 2: PoE total loading >100% PoE output budget

Key trigger event 3: PoE over current per port

Key trigger event 4: Cable short per port

Key trigger event 5: One of the channels in Dual PD fail

[Notice] When the relay is triggered because of Event 2~5, the relay contact alarm, will update the status every 30 seconds. If there is no event happening for 30 seconds, the relay contact alarm will be turn off. If the user disables the failed PoE port by removing the cable or Dip Switch manually, the relay will be recovered immediately.

Ethernet Ports

RJ-45 Ports (Auto MDI/MDIX)

The RJ-45 ports are auto-sensing for 10Base-T, 100Base-TX or 1000Base-T devices connections. Auto MDI/MDIX means that the switch can connect to another switch or workstation without changing the straight-through or crossover cabling. See the figures as below for straight-through and crossover cabling schematics.

1 2 3 4 5 6 7 8

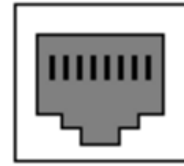

RJ-45 Female

10/100BASE-T(X) RJ-45 Pin Assignments (Table 2.2)

Crossover Cable		Straight Through Cable	
Pin Number / Signal	Pin Number / Signal	Pin Number / Signal	Pin Number / Signal
1 / RX+	3 / TX+	1 / RX+	1 / TX+
2 / RX-	6 / TX-	2 / RX-	2 / TX-
3 / TX+	1 / RX+	3 / TX+	3 / RX+
6 / TX-	2 / RX-	6 / TX-	6 / RX-

Table 2.2

1000BASE-T RJ-45 Pin Assignments (Table 2.3)

Crossover Cable		Straight Through Cable	
Pin Number / Signal	Pin Number / Signal	Pin Number / Signal	Pin Number / Signal
1 / TP0+	3 / TP1+	1 / TP0+	1 / TP1+
2 / TP0-	6 / TP1-	2 / TP0-	2 / TP1-
3 / TP1+	1 / TP0+	3 / TP1+	3 / TP0+
4 / TP2+	7 / TP3+	4 / TP2+	4 / TP3+
5 / TP2-	8 / TP3-	5 / TP2-	5 / TP3-
6 / TP1-	2 / TP0-	6 / TP1-	6 / TP0-
7 / TP3+	4 / TP2+	7 / TP3+	7 / TP2+
8 / TP3-	5 / TP2-	8 / TP3-	8 / TP2-

Table 2.3

Note: “+” and “-” signs represent the polarity of the wires that make up each wire pair.

Cabling

Use the four twisted-pair, category 5e, or the above cabling for RJ-45 port connections. The cable between the Switch and the link partner (switch, hub, workstation, etc.) must be less than 100 meters (328 ft.) long.

The small form-factor pluggable (SFP) is a compact optical transceiver used in optical communications for both telecommunication and data communication applications.



Caution: Please employ optional optical transceiver (SFP/Fixed Fiber) that complies with IEC 60825-1 and classified as Class 1 laser product.



Attention: Veuillez utiliser un émetteur-récepteur optique (SFP) conforme à la norme CEI 60825-1 et classé comme produit laser de classe 1.

To connect the transceiver and LC cable, please follow below steps:

Step 1. Insert the SFP transceiver module into the SFP slot as shown below in Figure 2.4. Notice that the triangle mark is at the bottom of the SFP slot. Figure 2.5 shows SFP transceiver module was inserted.

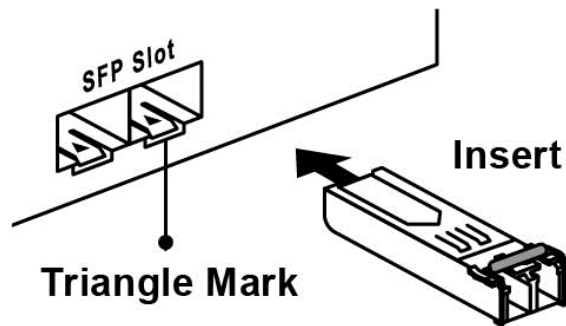

Figure 2.4: Transceiver to the SFP Module

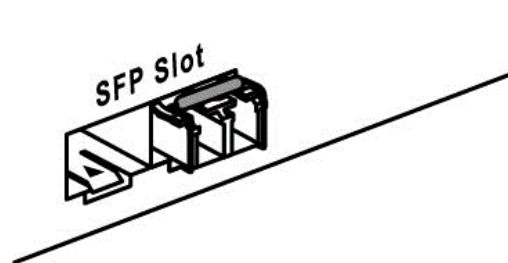

Figure 2.5: Transceiver Inserted

Step 2. Insert the fiber cable of the LC connector into the transceiver as shown below in Figure 2.6.

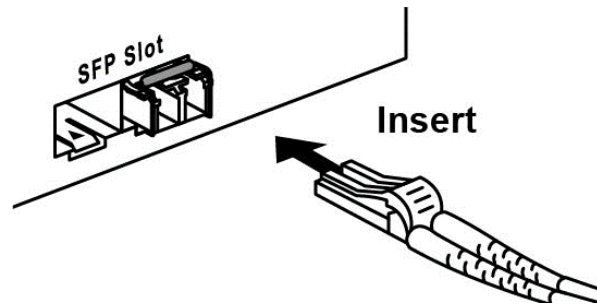

Figure 2.6: LC Connector to the Transceiver

To remove the LC connector from the transceiver, please follow the steps shown below:

Step 1. Press the upper side of the LC connector from the transceiver and pull it out to release as shown below in Figure 2.7

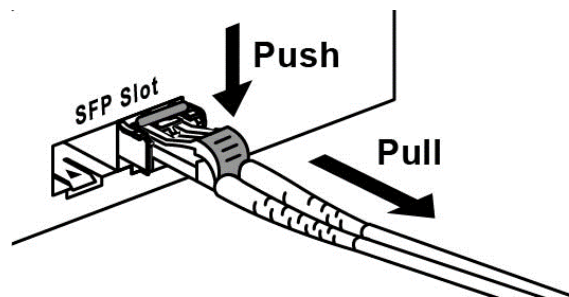

Figure 2.7: Remove LC Connector

Step 2. Push down the metal clasp and pull the transceiver out by the plastic part as shown below in Figure 2.8

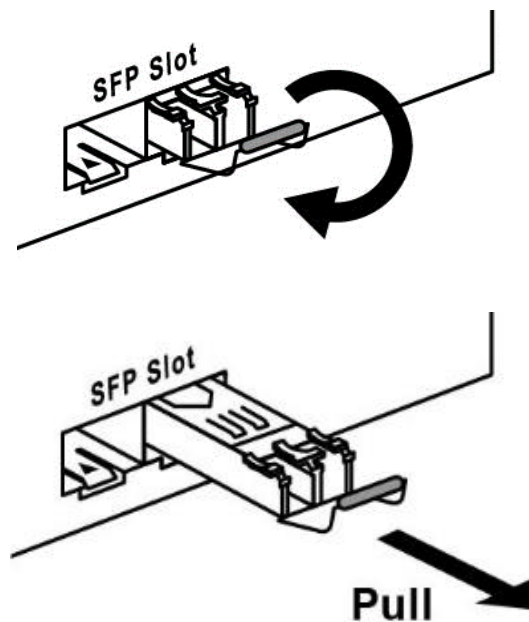

Figure 2.8: Pull Out from the SFP Module

Wiring the Power Inputs



Caution: Please follow the below steps to insert the power wire.



Attention: Veuillez suivre les étapes ci-dessous pour insérer le câble d'alimentation.

Step 1. Insert the positive and negative wires into the PWR1 (V1+, V1-) and PWR2 (V2+, V2-) contacts on the terminal block connector as shown below in Figure 2.9.

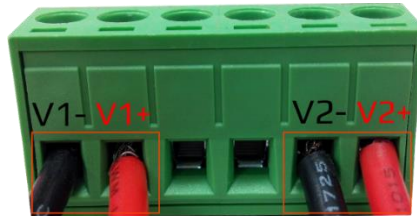

Figure 2.9: Power Terminal Block

Step 2. Tighten the wire-clamp screws to prevent the wires from loosening, as shown below in Figure 2.10.

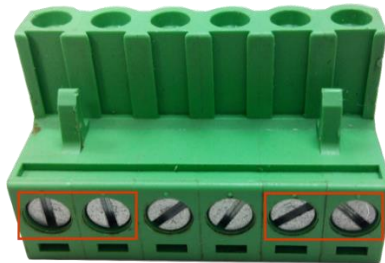

Figure 2.10: Power Terminal Block



Caution: Only use copper conductors, 125°C, tighten to 7 in-lbs (0.79 Nm). The wire gauge for the terminal block should range between 18~20 AWG.



Attention: Utilisez uniquement des conducteurs en cuivre, 125 °C, serrer à 7 in-lbs (0,79 Nm). Le calibre des fils du bornier doit être compris entre 18 et 20 AWG.

Wiring the Fault Alarm Contact

The fault alarm contact is in the middle of the terminal block connector as the picture shows below in Figure 2.11. By inserting the wires, it will detect the fault status including power failure or port link failure (managed industrial switch only) and form a normally open circuit. An application example for the fault alarm contact is shown below in Figure 2.11.

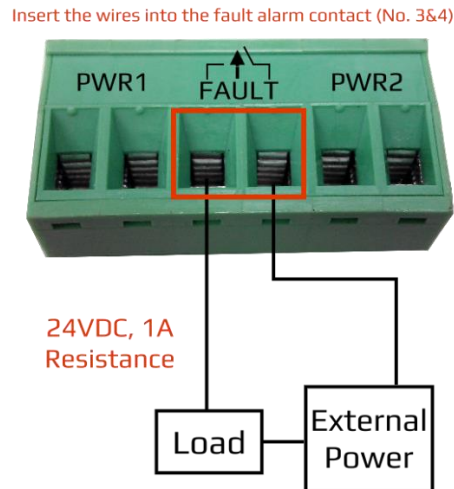

Figure 2.11: Wiring the Fault Alarm Contact



Caution: The wire gauge for the terminal block should range between 12 ~ 24 AWG.

If only using one power source, jumper Pin 1 to Pin 5 and Pin 2 to Pin 6 to eliminate power fault alarm.



Attention: Le calibre des fils du bornier doit être compris entre 12 et 24 AWG.

Si vous n'utilisez qu'une seule source d'alimentation, jumelez les broches 1 à 5 et les broches 2 à 6 pour éliminer l'alarme de panne de courant.

Grounding Note

Grounding and wire routing help limit the effects of noise due to electromagnetic interference (EMI). Run the ground connection from the ground screw to the grounding surface prior to connecting devices. The grounding screw symbol is shown below in Figure 2.12.

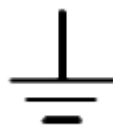

Figure 2.12: Grounding screw symbol



Caution: Using a shielded cable achieves better electromagnetic compatibility.



Attention: L'utilisation d'un câble blindé permet une meilleure compatibilité électromagnétique.

MOUNTING INSTALLATION

DIN-Rail Mounting

The DIN-Rail is pre-installed on the industrial Ethernet Switch from the factory. If the DIN-Rail is not on the industrial Ethernet Switch, please see Figure 3.1 to learn how to install the DIN-Rail on the Switch.



Figure 3.1: The Rear Side of the Switch and DIN-Rail Bracket

Follow the steps below to learn how to hang the industrial Switch.

Step 1. Use the screws to install the DIN-Rail bracket on the rear side of the industrial Switch.

Step 2. To remove the DIN-Rail bracket, do the opposite from Step 1.

Step 3. After the DIN-Rail bracket is installed on the rear side of the Switch, insert the top of the DIN-Rail on to the track as shown below in Figure 3.2.

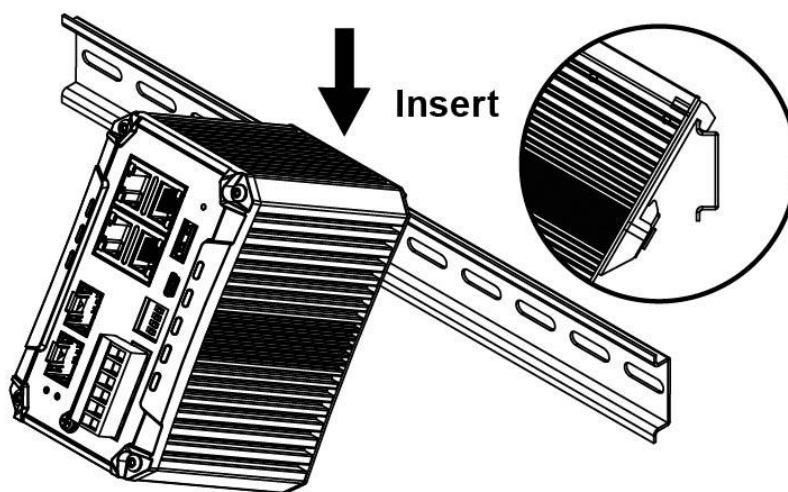

Figure 3.2: Insert the Switch on the DIN-Rail

Step 4. Lightly pull down the bracket on to the rail as shown below in Figure 3.3.

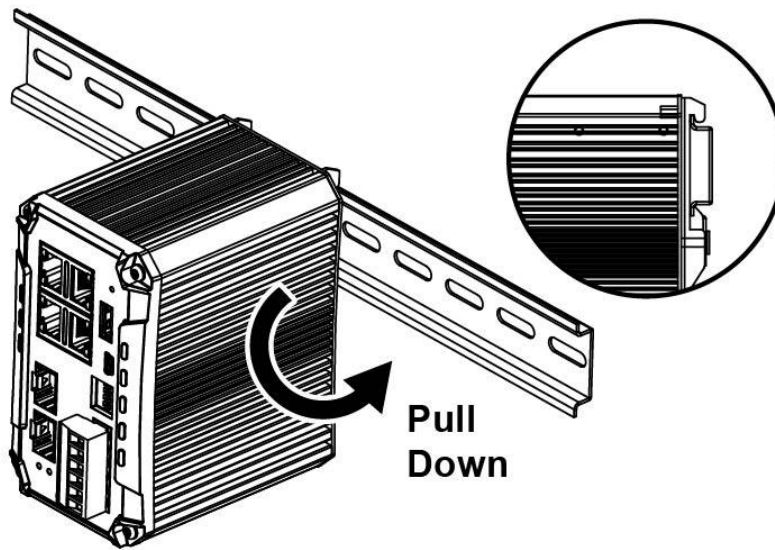

Figure 3.3: Stable the Switch on DIN-Rail

Step 5. Check if the bracket is mounted tightly on the rail.

Step 6. To remove the industrial Switch from the rail, do the opposite from the above steps.

Wall Mounting

Follow the steps below to mount the industrial Switch using the wall mounting bracket as shown below in Figure 3.4.

Step 1. Remove the DIN-Rail bracket from the industrial Switch by loosening the screws.

Step 2. Place the wall mounting brackets on the top and bottom of the industrial Switch.

Step 3. Use the screws to screw the wall mounting bracket on the industrial Switch.

Step 4. Use the hook holes at the corners of the wall mounting bracket to hang the industrial Switch on the wall.

Step 5. To remove the wall mount bracket, do the opposite from the steps above.

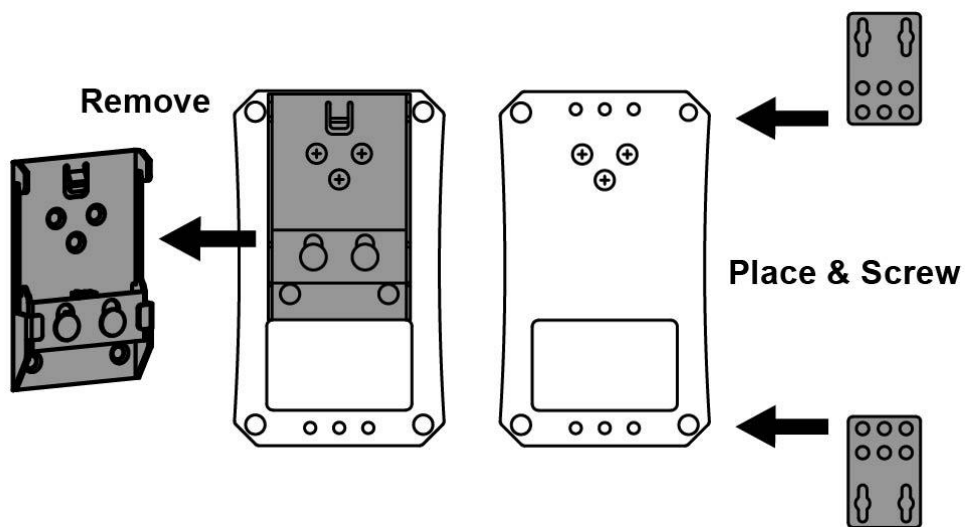

Figure 3.4: Remove DIN-Rail Bracket from the Switch and Install the Wall Mount Bracket

Below, in Figure 3.5 are the dimensions of the wall mounting bracket.

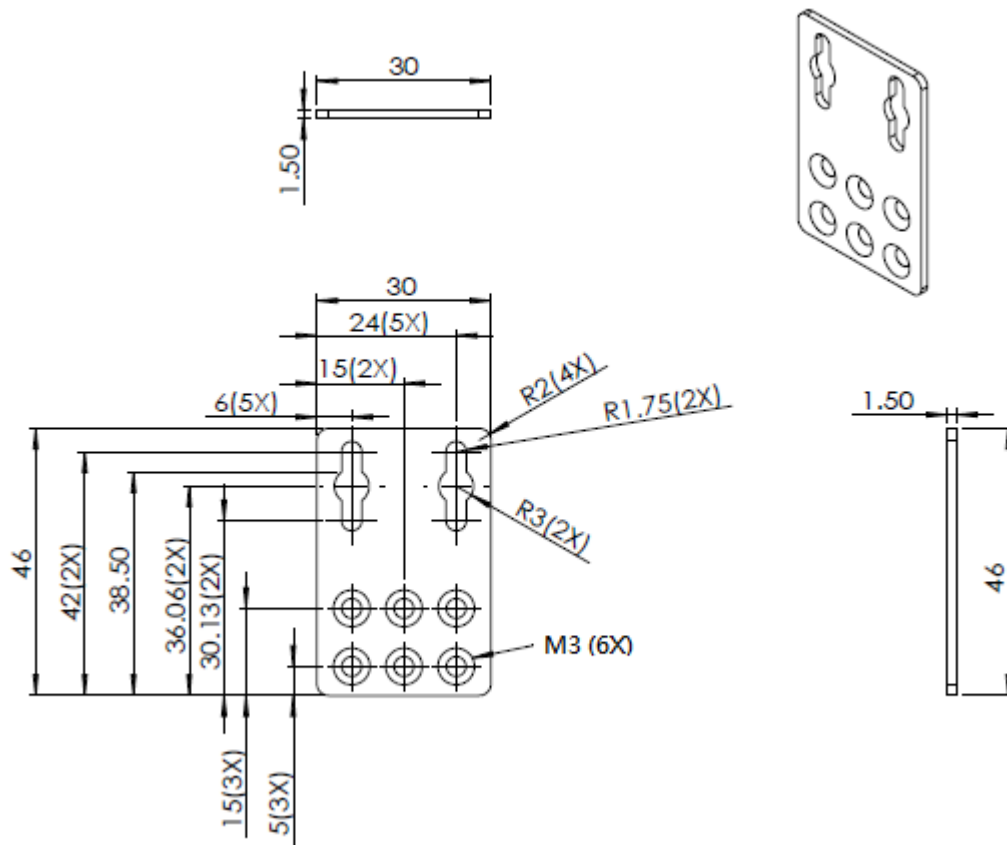

Figure 3.5: Wall Mounting Bracket Dimensions

HARDWARE INSTALLATION

Installation Steps

This section will explain how to install CBG5-0602-SFP series.

Installation Steps

Step 1. Unpack the industrial Switch from the original packing box.

Step 2. Check if the DIN-Rail bracket is screwed on the industrial Switch.

- If the DIN-Rail is not screwed on the industrial Switch, please refer to the **DIN-Rail Mounting** section for DIN-Rail installation.
- If you want to wall mount the industrial Switch, please refer to the **Wall Mounting** section for wall mounting installation.

Step 3. To hang the industrial Switch on a DIN-Rail or wall, please refer to the **Mounting Installation** section.

Step 4. Power on the industrial Switch and then the power LED light will turn on.

- If you need help on how to wire power, please refer to the **Wiring the Power Inputs** section.
- Please refer to the **LED Indicators** section for LED light indication.

Step 5. Prepare the twisted-pair, straight-through category 5 cable for Ethernet connection.

Step 6. Insert one side of the RJ-45 cable into Switch's Ethernet port and on the other side into the networking device's Ethernet port, e.g. switch PC or server. The Ethernet port's (RJ-45) LED on the industrial Switch will turn on when the cable is connected to the networking device.

- Please refer to the **LED Indicators** section for LED light indication.

Step 7. Insert one side of the SFP cable into Switch's SFP port and on the other side into the networking device's SFP port, e.g. switch or server. The SFP port's LED on the industrial Switch will turn on when the cable is connected to the networking device.

- Please refer to the **LED Indicators** section for LED light indication.

Step 8. When all connections are set and the LED lights all show normal, the installation is complete.



Caution: If the equipment is used in a manner not specified by the manufacturer, the protection provided by the equipment may be impaired.



Attention: Si l'équipement est utilisé d'une manière non spécifiée par le fabricant, la protection fournie par l'équipement peut être altérée.



Caution: The installation that the safety to any system incorporating the equipment is the responsibility of the assembler of the system.



Attention: L'installation que la sécurité de tout système intégrant l'équipement est de la responsabilité de l'assembleur du système.



Caution: This is an OPEN TYPE module and should be installed in a final safety enclosure characteristic.



Attention: Il s'agit d'un module de TYPE OUVERT et doit être installé dans une caractéristique finale d'enceinte de sécurité.



Caution: This device is intended for use indoor and at altitudes up to 2000 meters.



Attention: Cet appareil est destiné à être utilisé en intérieur et à des altitudes allant jusqu'à 2000 mètres.



Caution: Ambient Relative Humidity should be within the range of 5 and 95% (non-condensing).



Attention: L'humidité relative ambiante doit être comprise entre 5 et 95% (sans condensation).

TROUBLE SHOOTING

- Verify you have the right power cord or adapter. Never use a power supply or adapter with a non-compliant DC output voltage or it will burn the equipment.
- Select the proper UTP or STP cable in order to construct the network. Use an unshielded twisted-pair (UTP) or shield twisted-pair (STP) cable for RJ-45 connections: 100Ω Category 5e for 10M/100/1000Mbps. Also be sure that the length of any twisted-pair connection does not exceed 100 meters (328 feet).
- Diagnosing LED Indicators: To assist in identifying problems, the Switch can be easily monitored with the LED indicators which help to identify if any problems exist.
- ◆ Please refer to the LED Indicators section for LED light indication.
- If the power indicator LED does not turn on when the power cord is plugged in, the user may have a problem with the power cord. Check for loose power connections, power losses or surges at the power outlet.
- ◆ Please contact Leonton for technical support service, if the problem still cannot be resolved.
- If the industrial Switch LED indicators are normal and the connected cables are correct but the packets still cannot transmit, please check the system's Ethernet devices' configuration or status.

For any repair or maintenance needs, please contact us.

LEONTON TECHNOLOGIES, CO., LTD
9F-1, No.43, Fuxing Rd., Xindian Dist.,
New Taipei City, 231,
Taiwan
TEL: +886 2 22183113
FAX: +886 2 22187391